

Quiz #11 EE 220 Fall 2017 Name: _____

Closed book and notes.

Show your work for credit!

1. Plot V_{out} vs. time for the following circuit for times ranging from 0 to 10 μs . Assume that the capacitor is initially discharged. Note that to get credit you need to correctly label your plot's axis. (2 points)

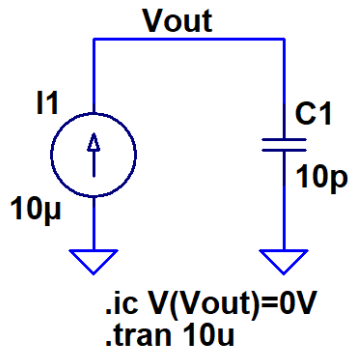

2. The following voltage, v_{out} , is applied to a 10 pF capacitor. Plot the current through the capacitor **on this same plot** using the right side of the plot. Hint: $I = C \cdot dv_{out}/dt$. (3 points)

