

EE 421 / ECG 621

Lecture 7

Sept. 11, 2018

Digital IC DESIGN

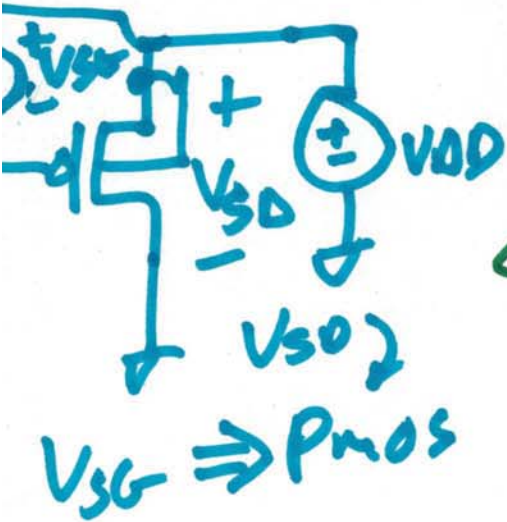
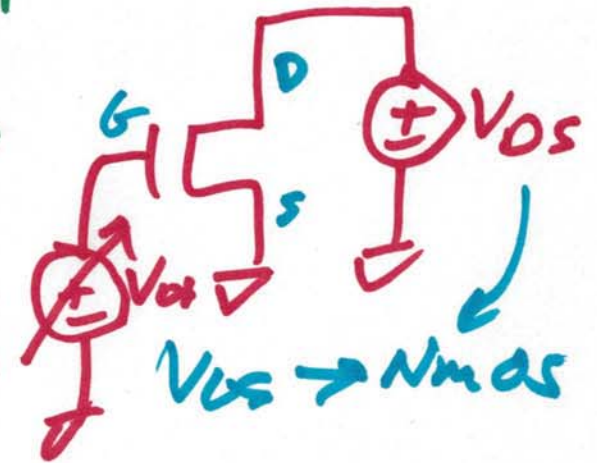

IV characteristics

$V_s - V_c = V_{sg}$



Hose bibb

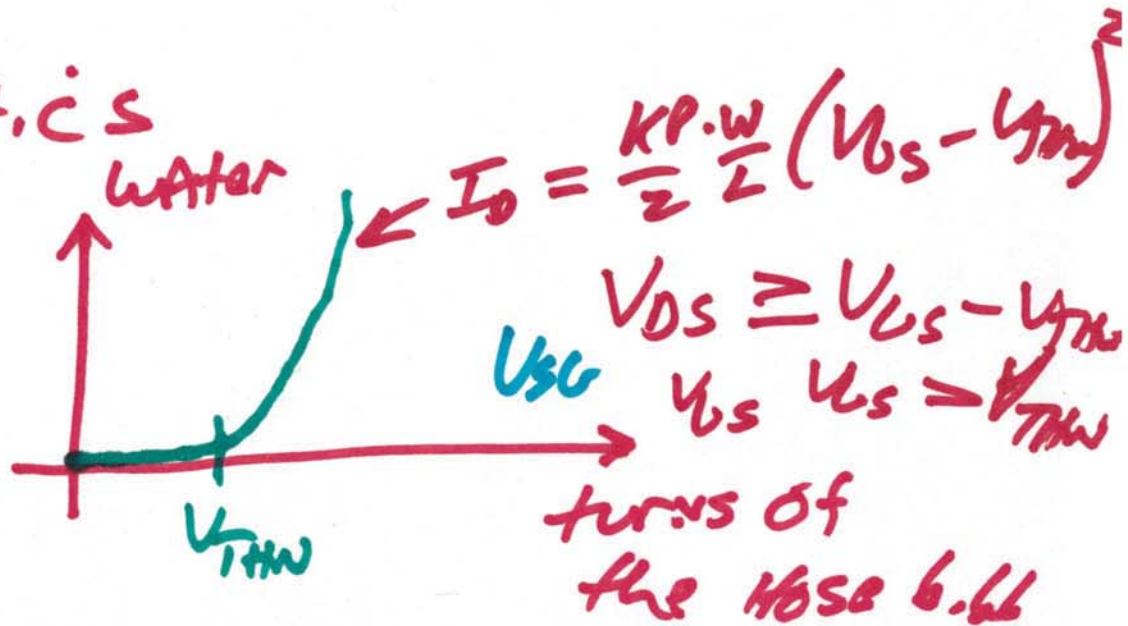

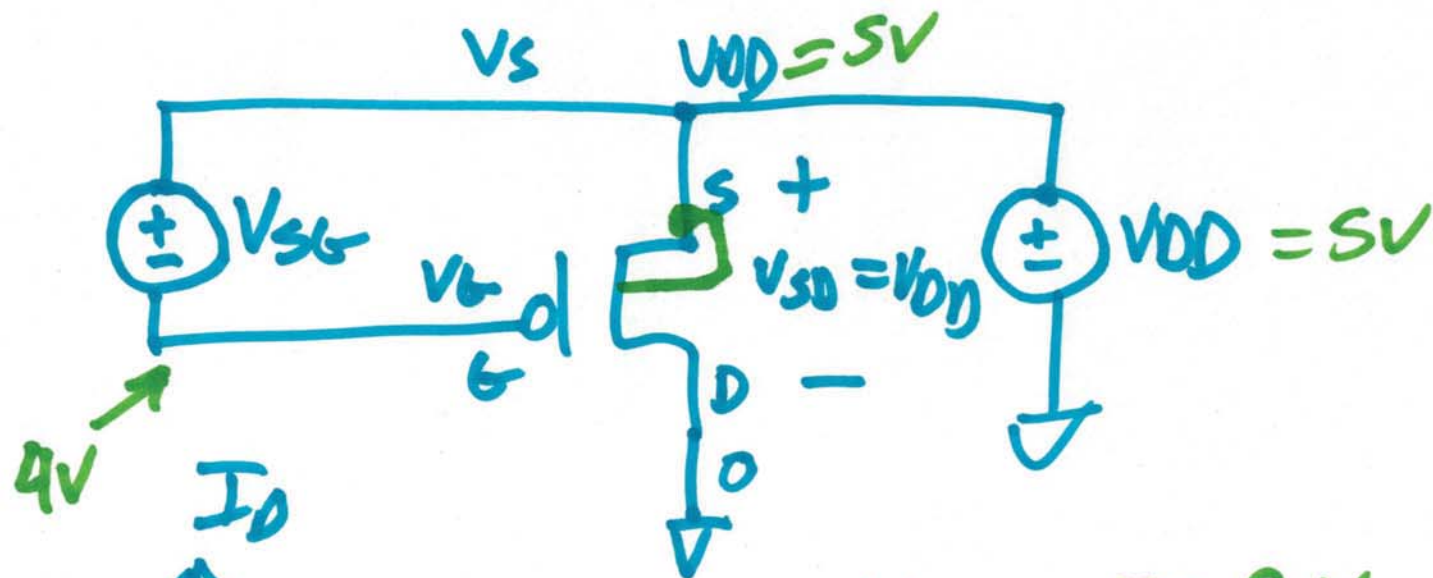

$V_{THP} = 0.9V$

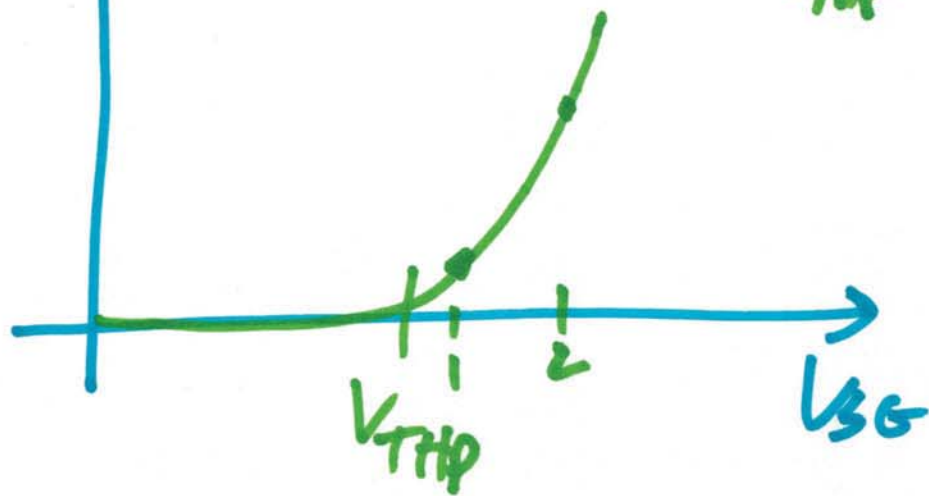

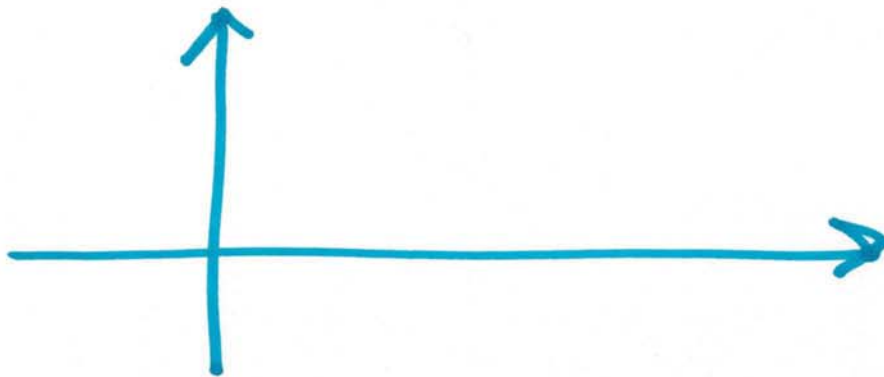
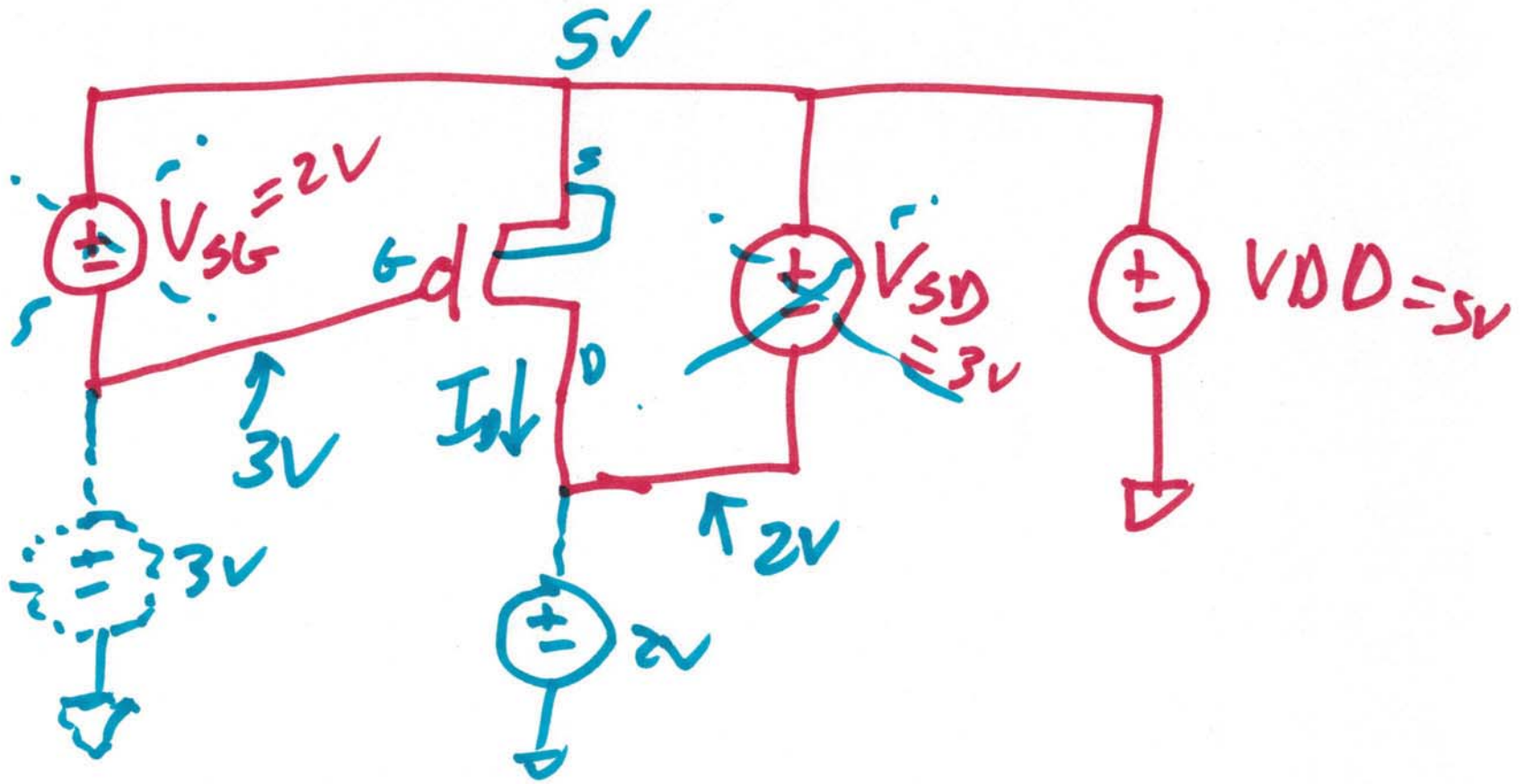

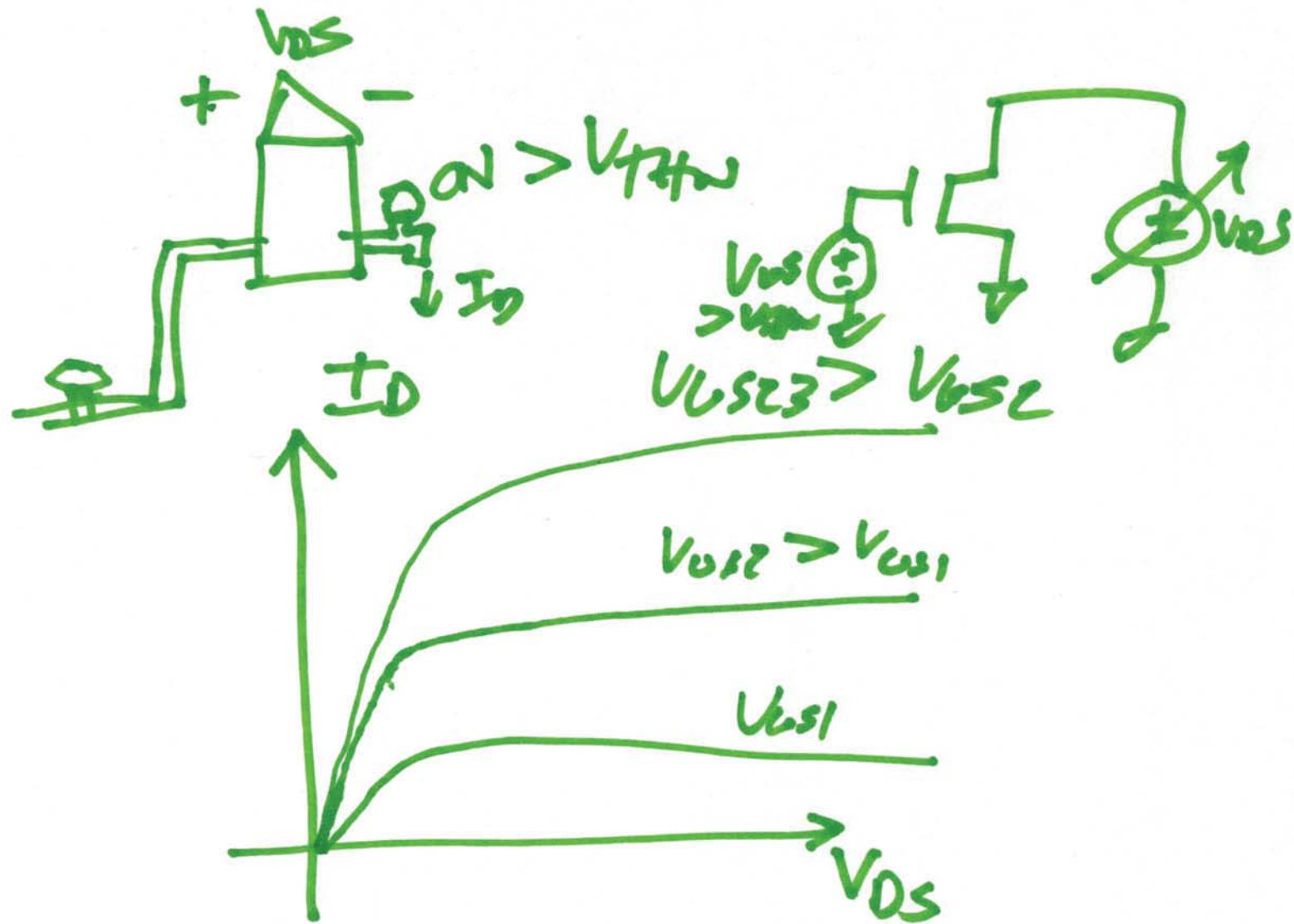

4)

p-active

LAYOUT OF NMOS

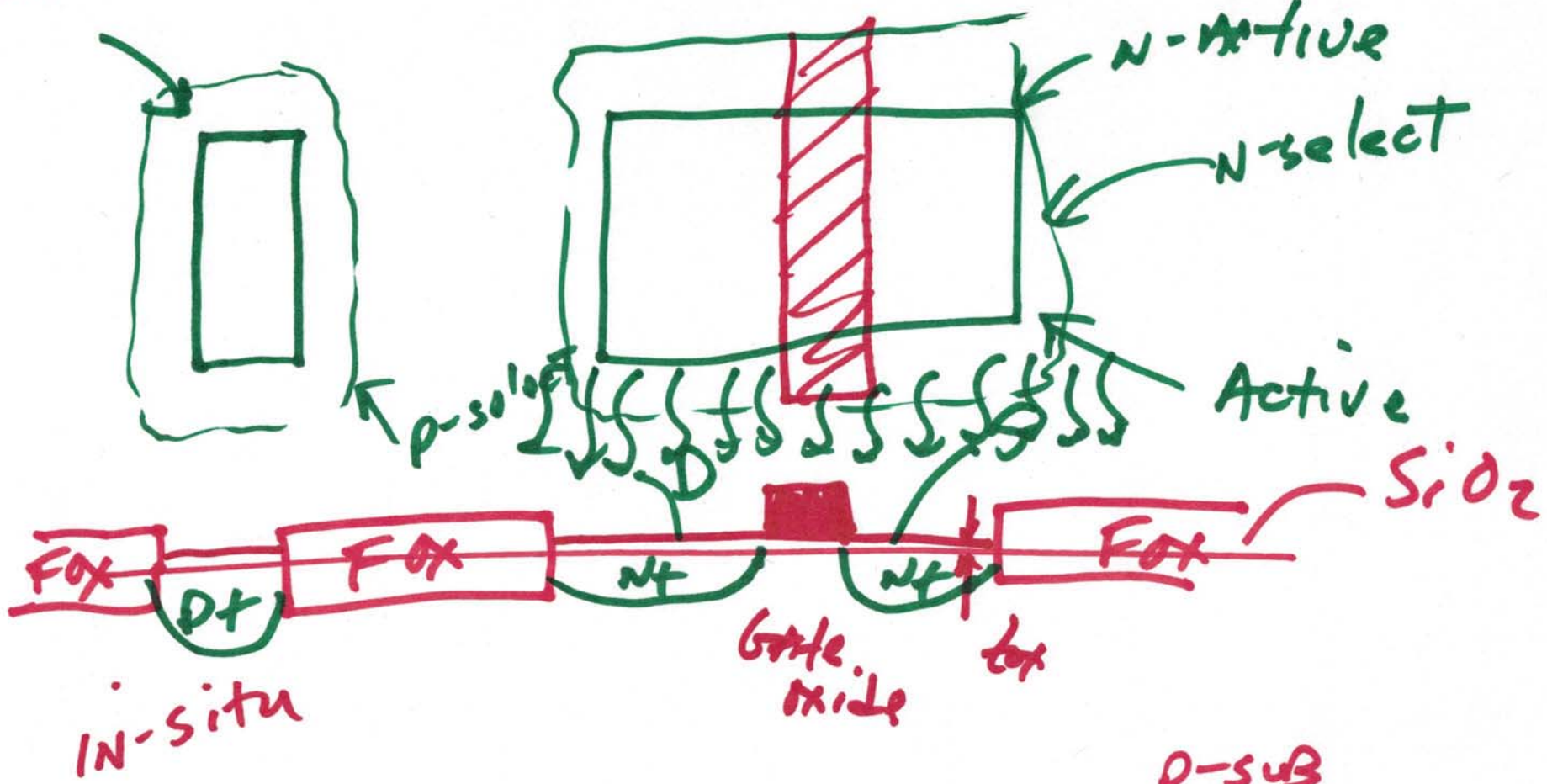

$$1.39 \times 10^{-8} = 139 \times 10^{-10}$$

$$13.9 \text{ nm} = 139 \text{ \AA}$$

$$\approx 0.0139 \mu\text{m}$$

5)

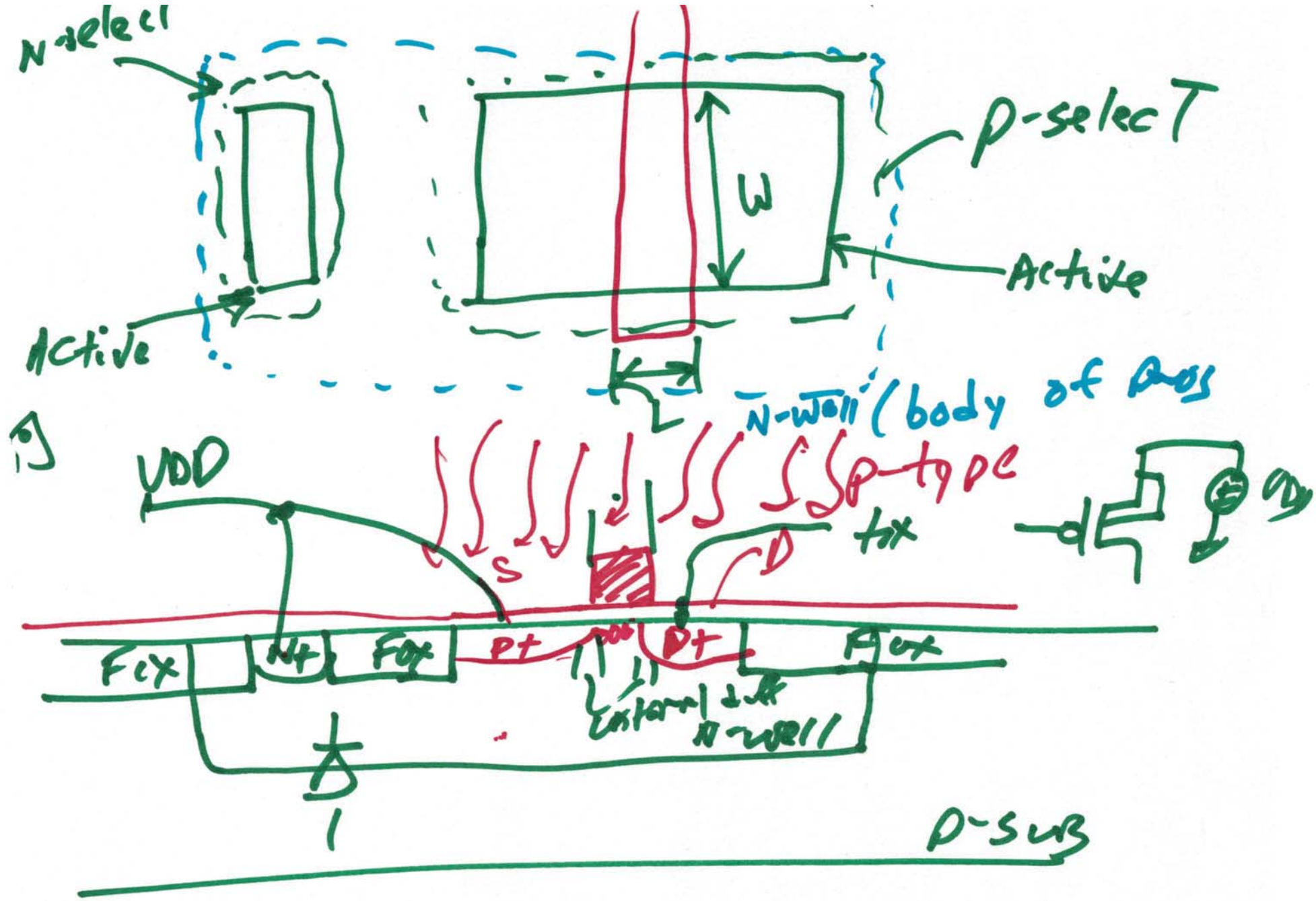

6)

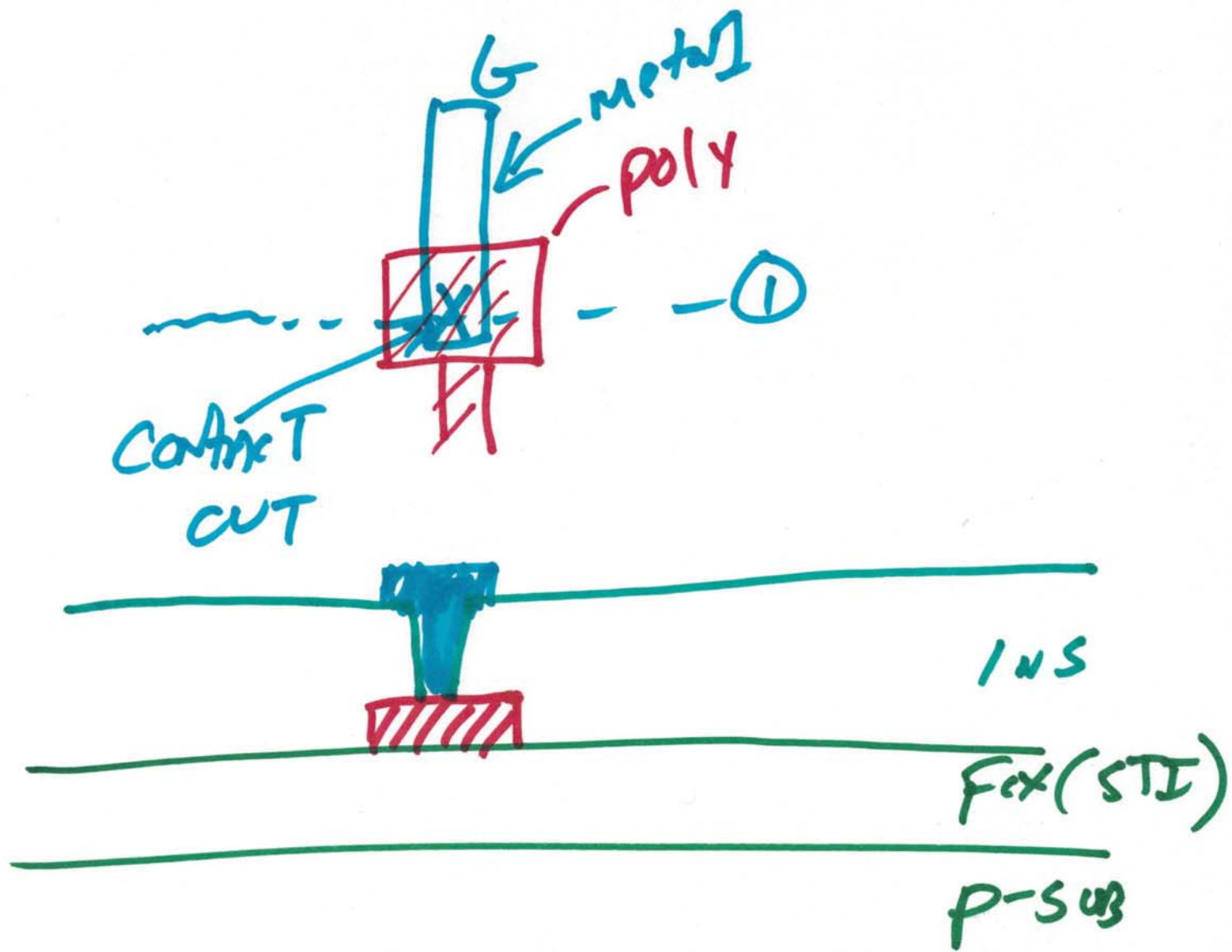

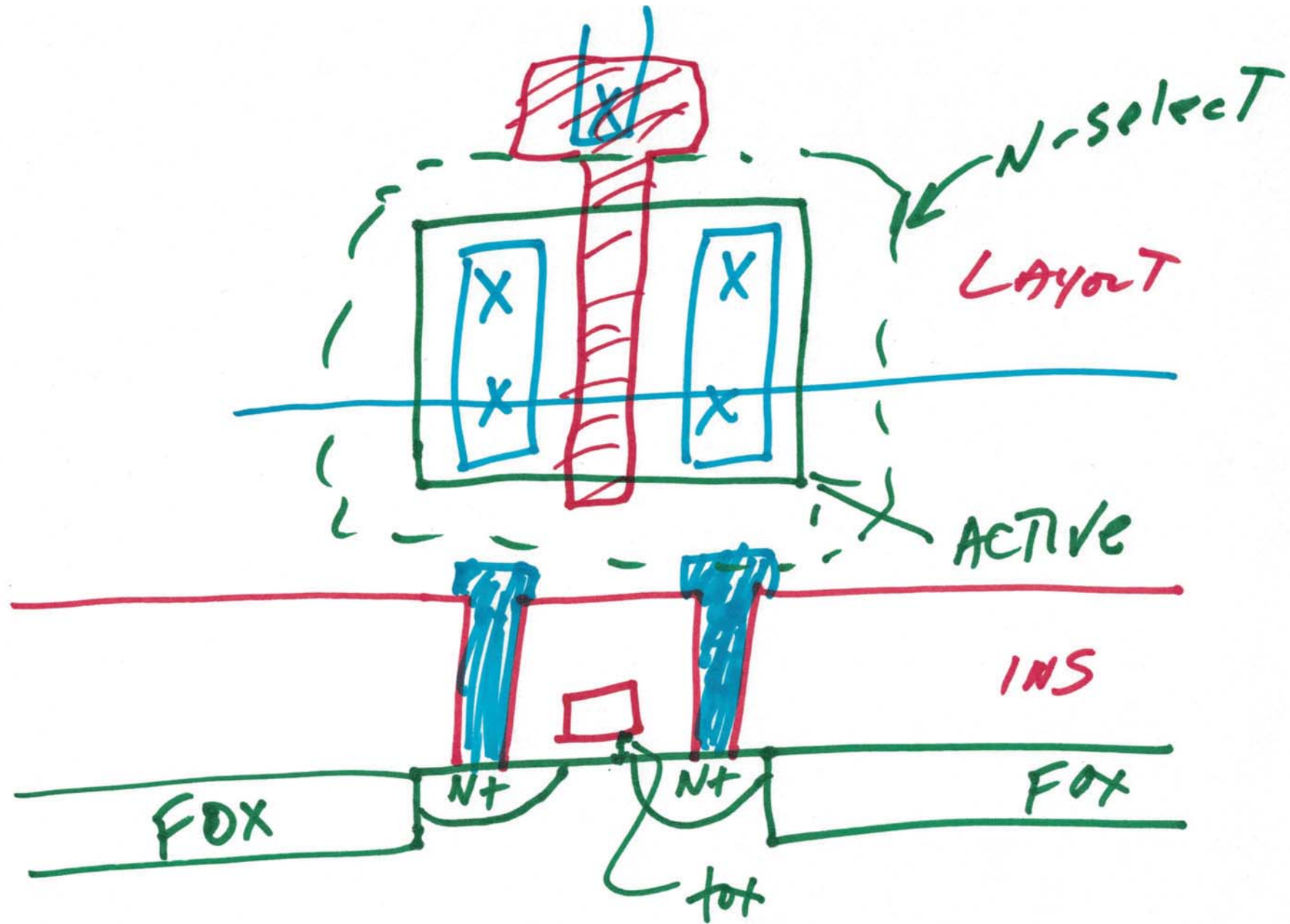

8)