

EE 421 / ECG 621

Digital IC Design

Lecture 26

December 2, 2019

$$I = C \frac{dv}{dt}$$

$$\frac{dv}{dt} = \frac{I_{off,P}}{C_{oxp} + C_{sw}}$$

$$\frac{1V}{ns}$$

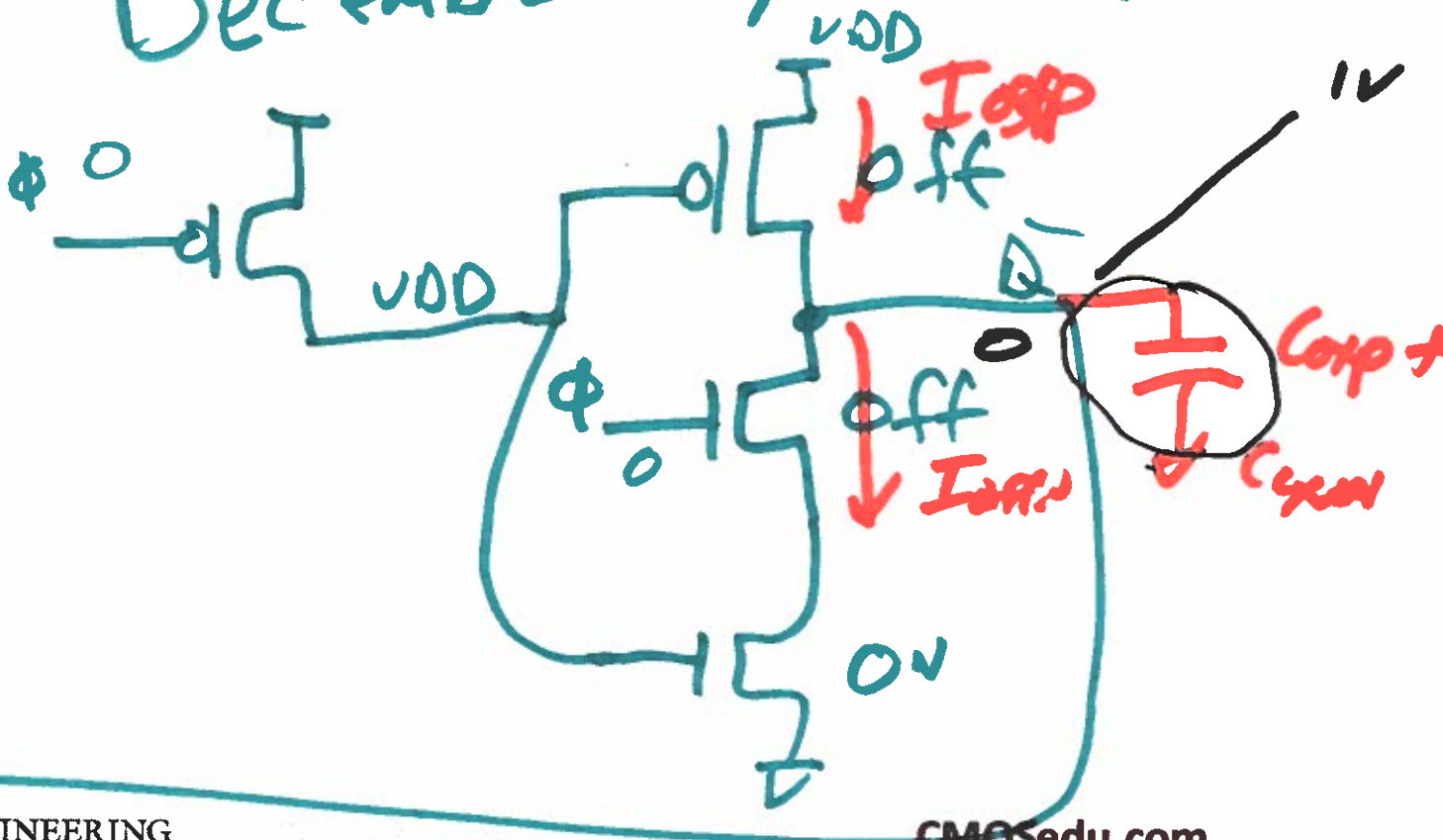
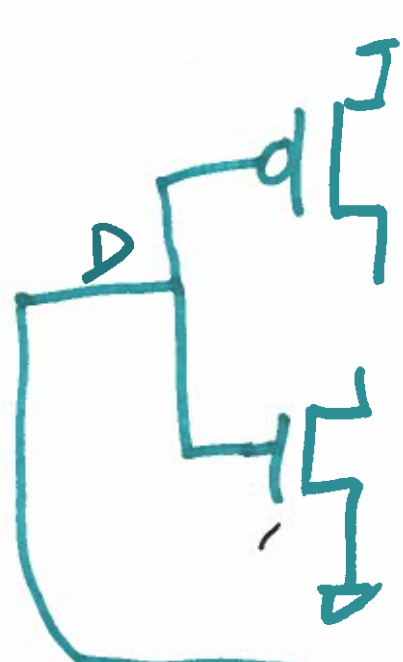

11

6T-5RAM

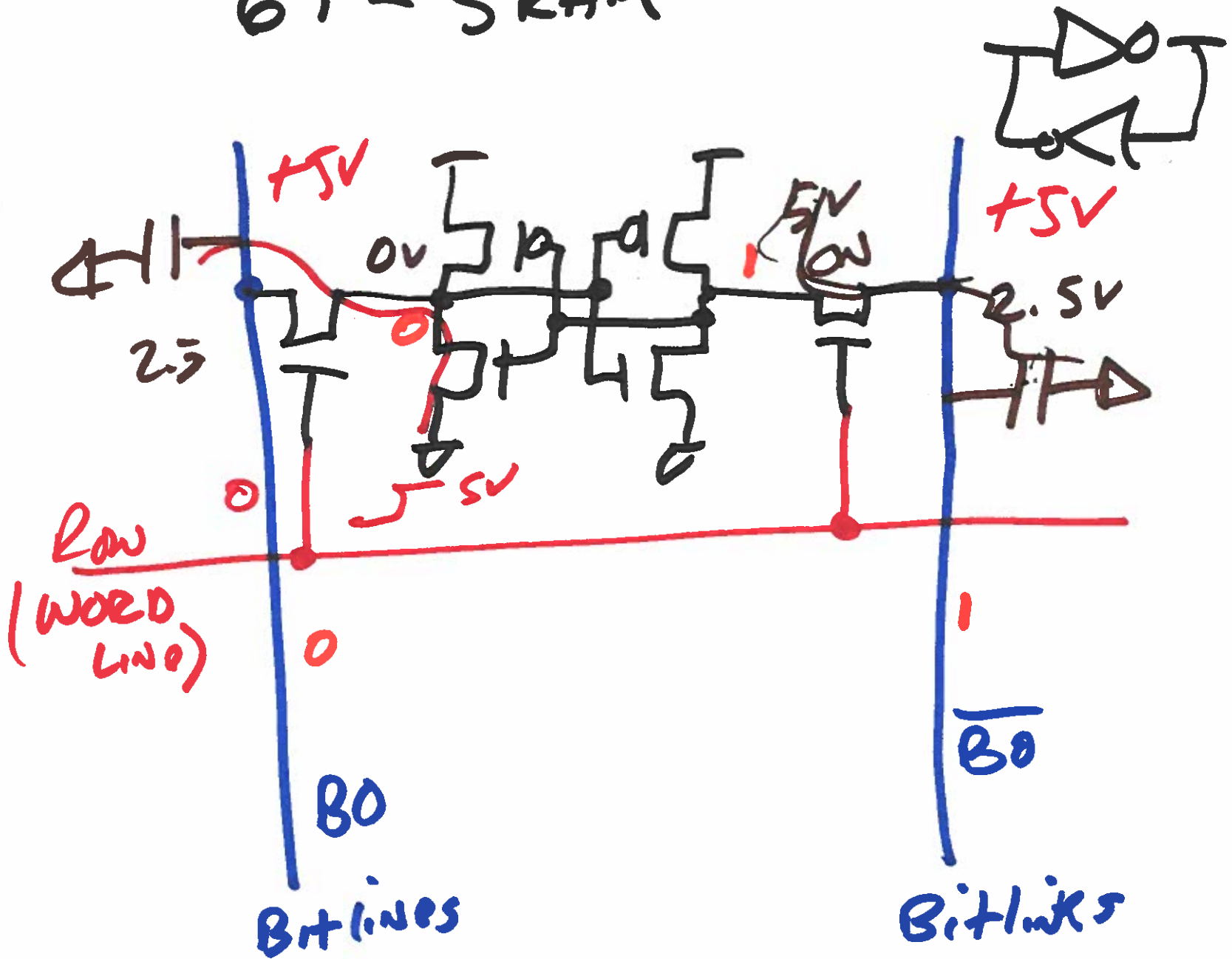

2)

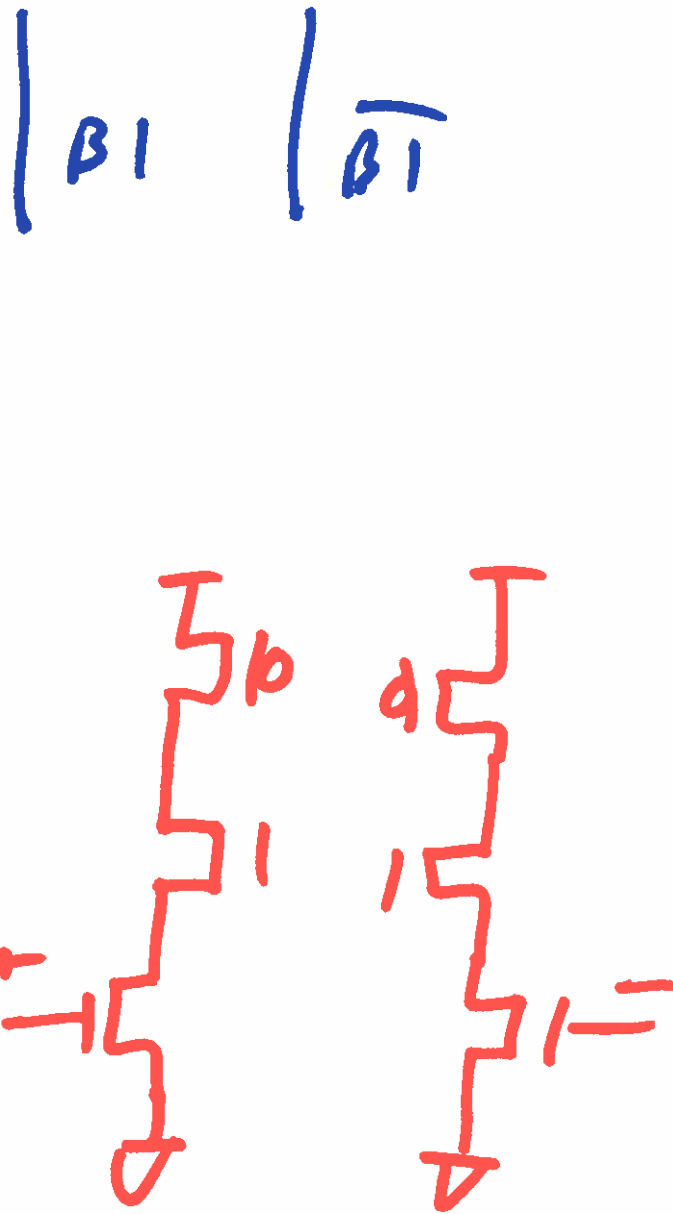
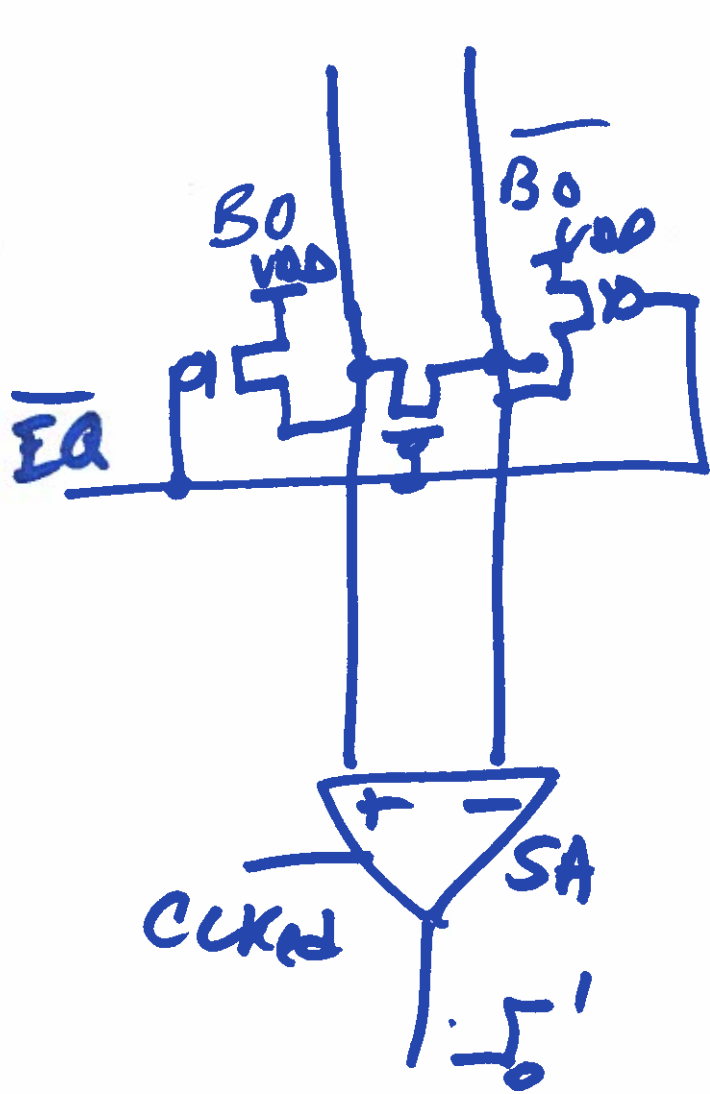

3)

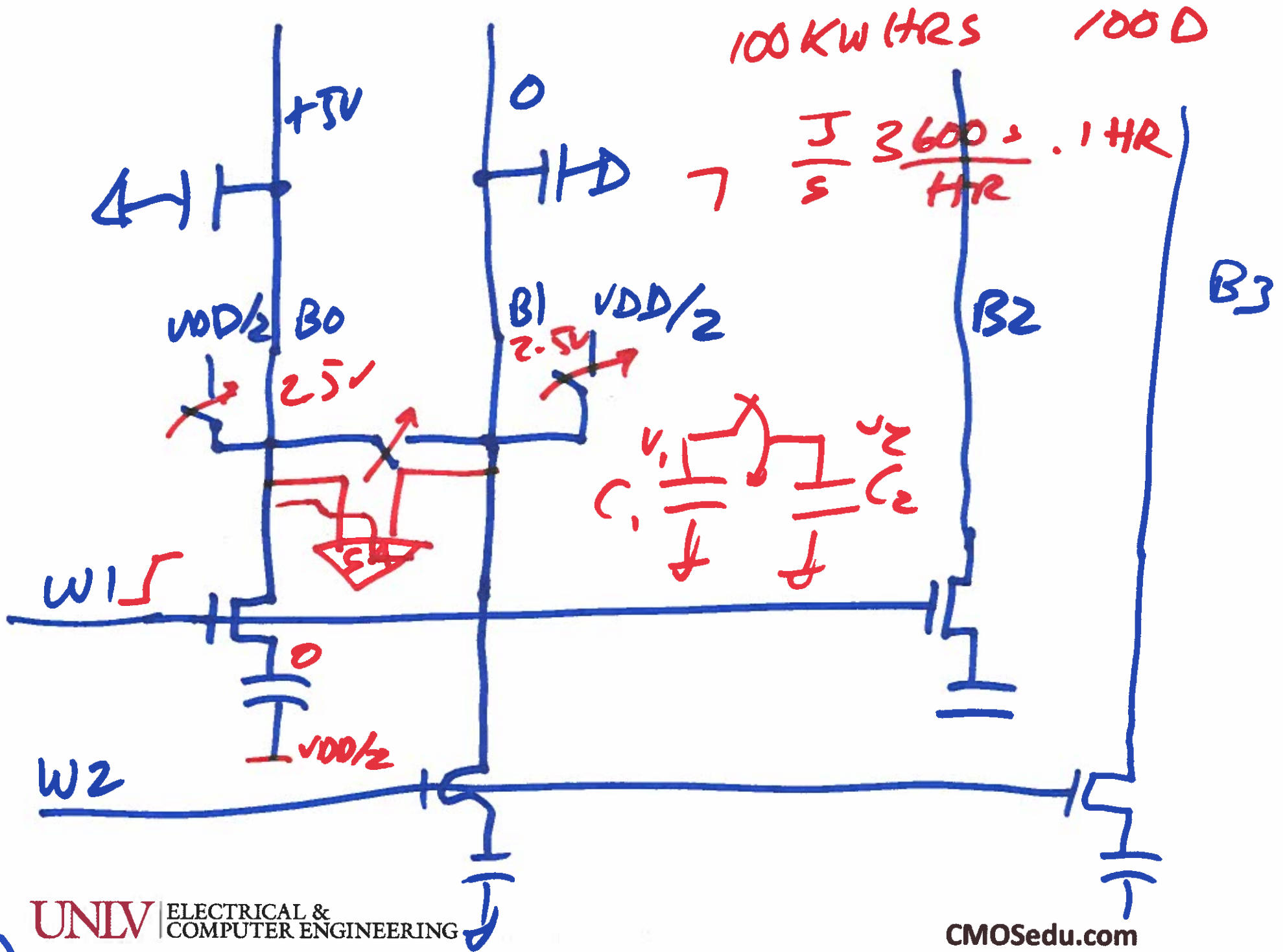

4)

PCIe

Flash

memory

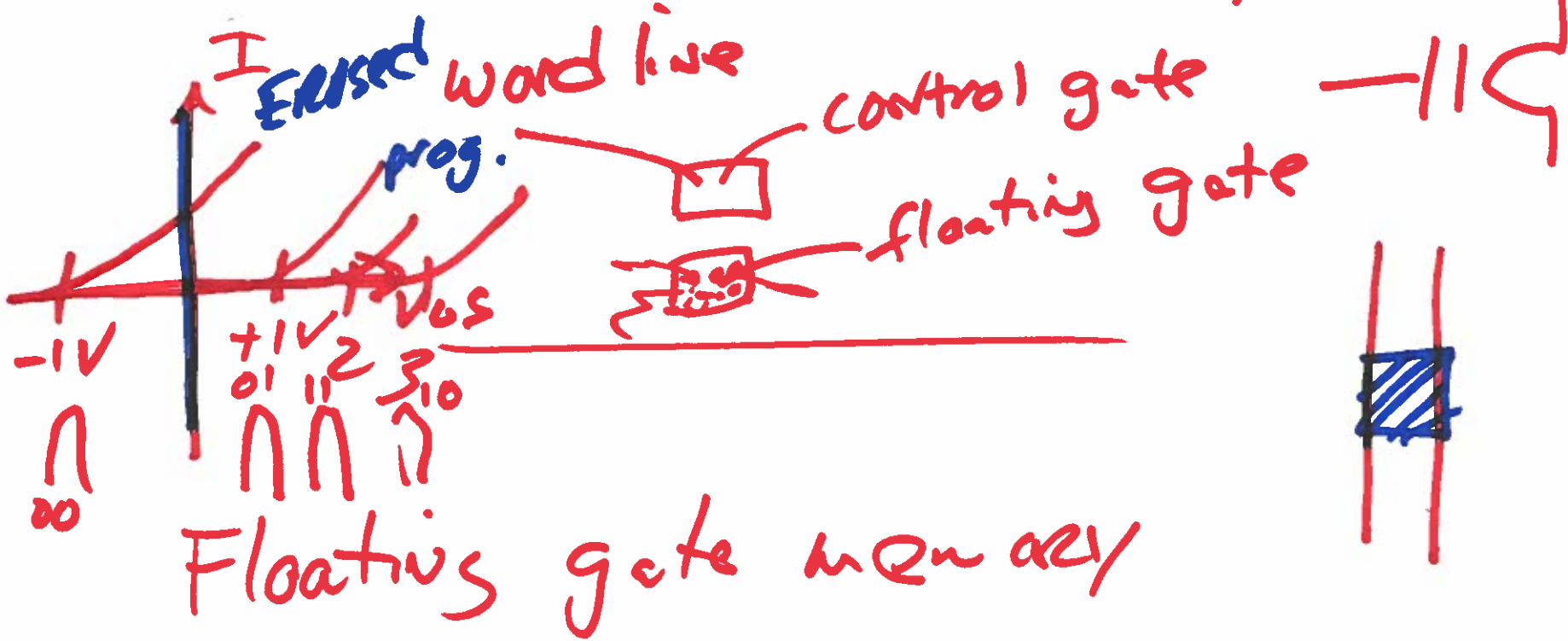

Floating gate memory

EEPROM

EPROM → electrical programmable
 erasable Read ONLY MEMORY